

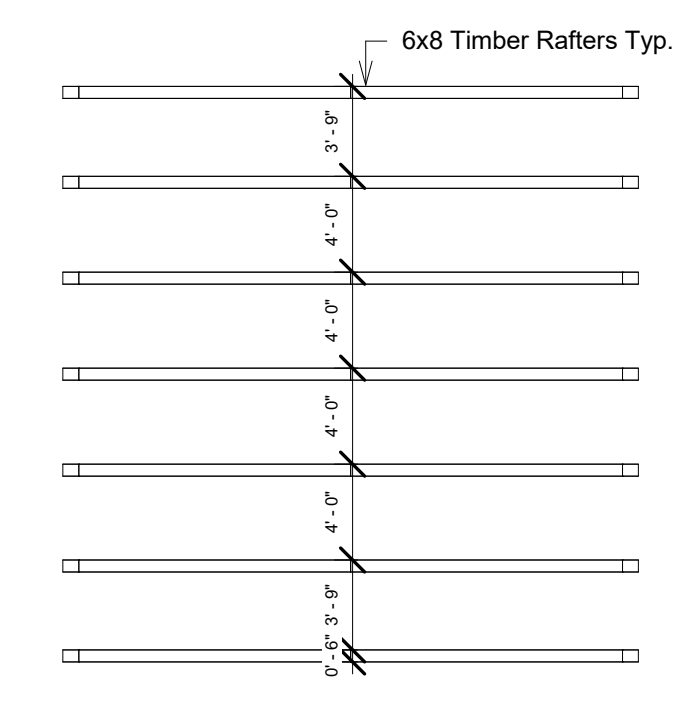

29130 Taylor Rd  
Dennison, Ohio 44621  
Phone 330-440-2717  
Email rrdrafting68@gmail.com

Reynolds Timber Frame Building  
Waite Hill, Ohio 44094

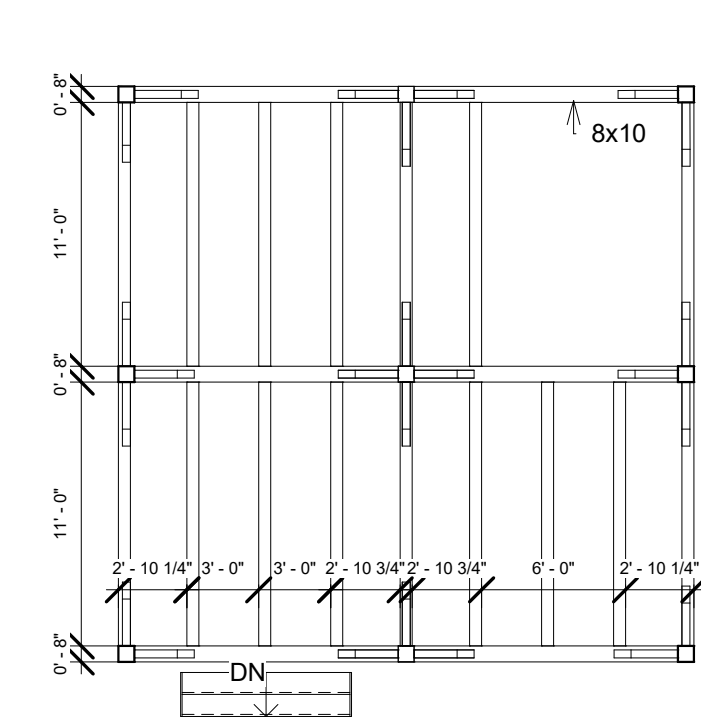
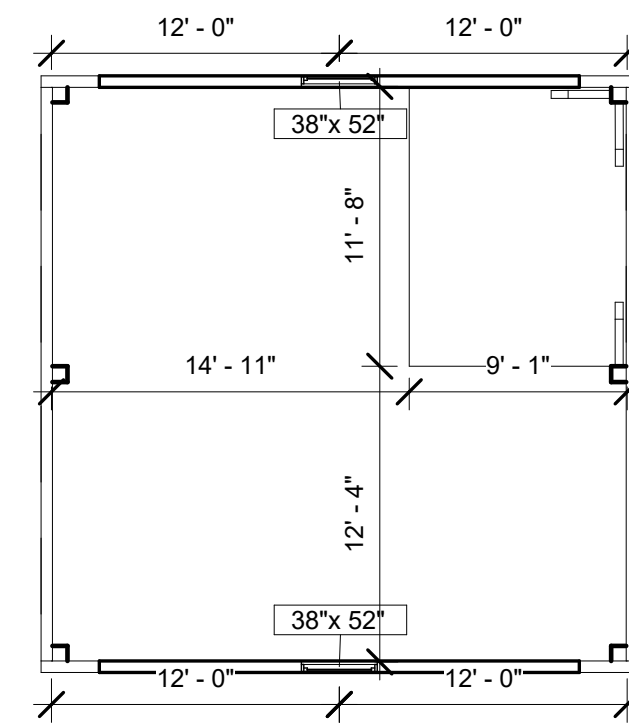
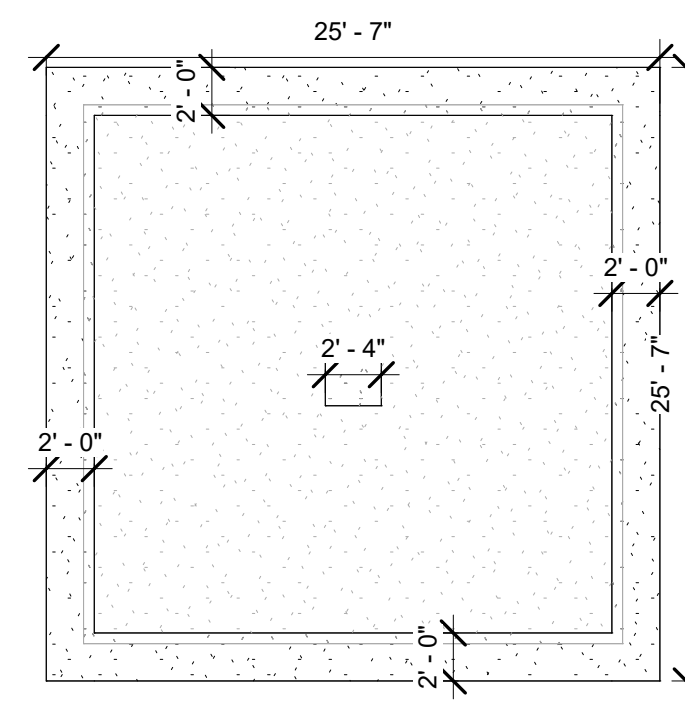
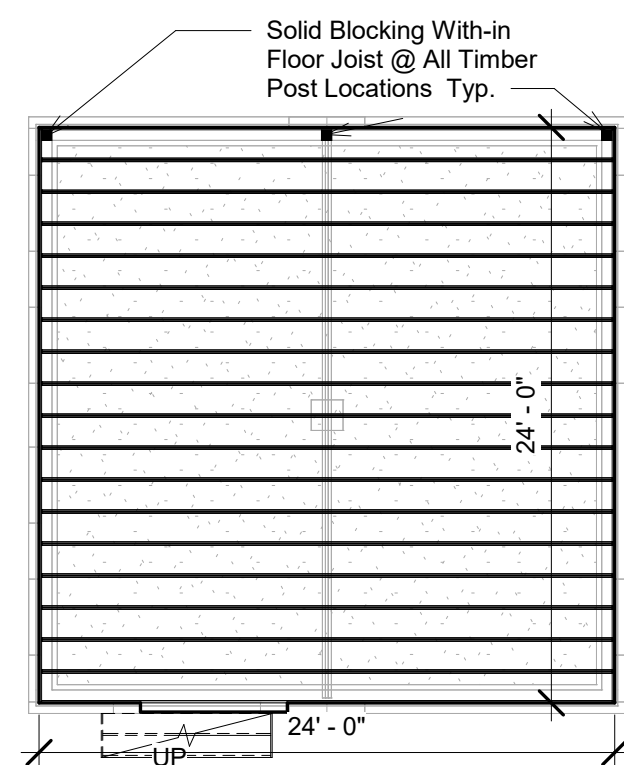
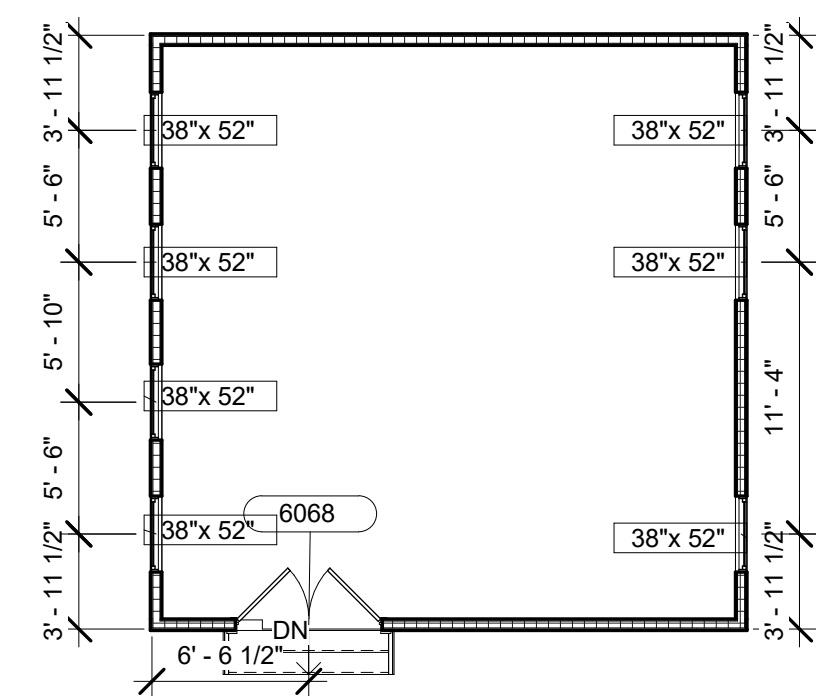
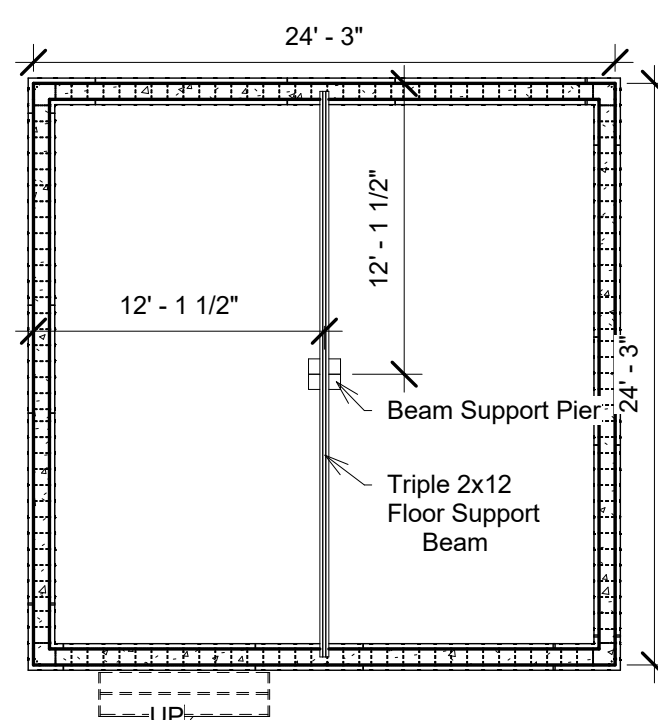
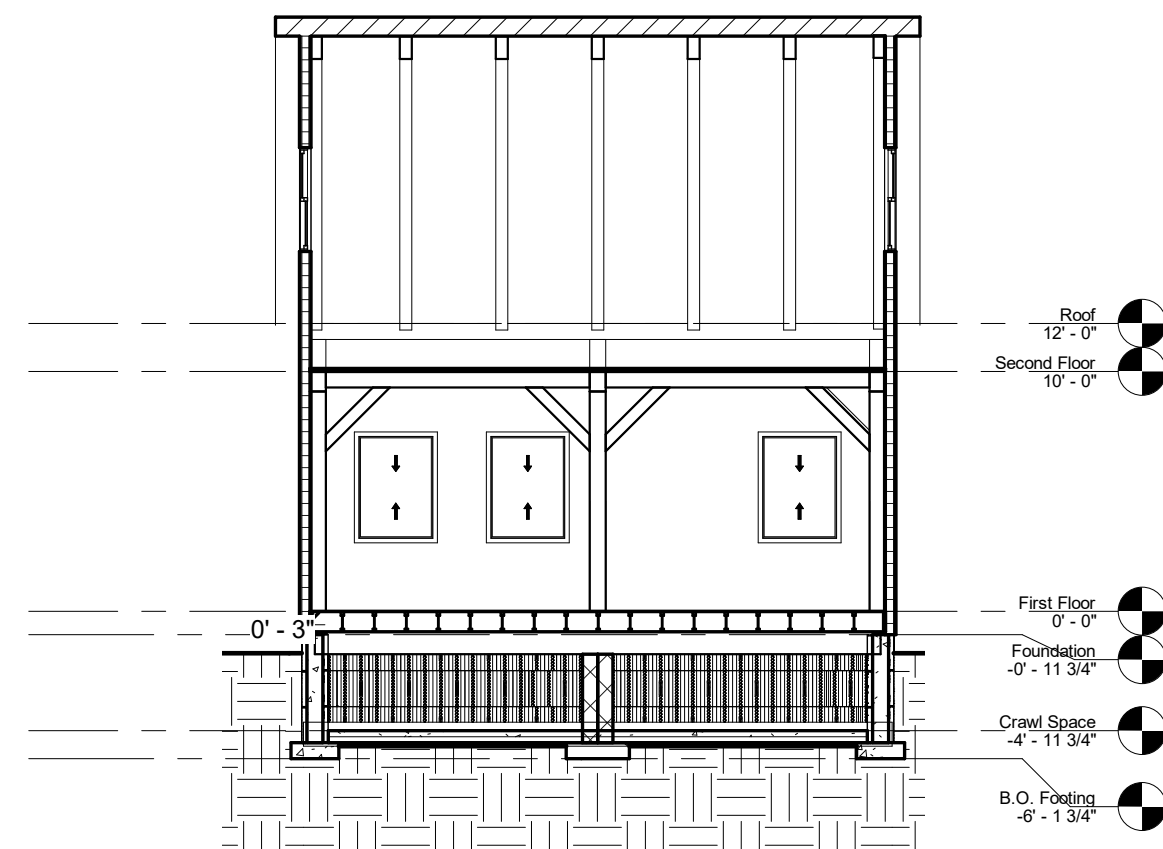
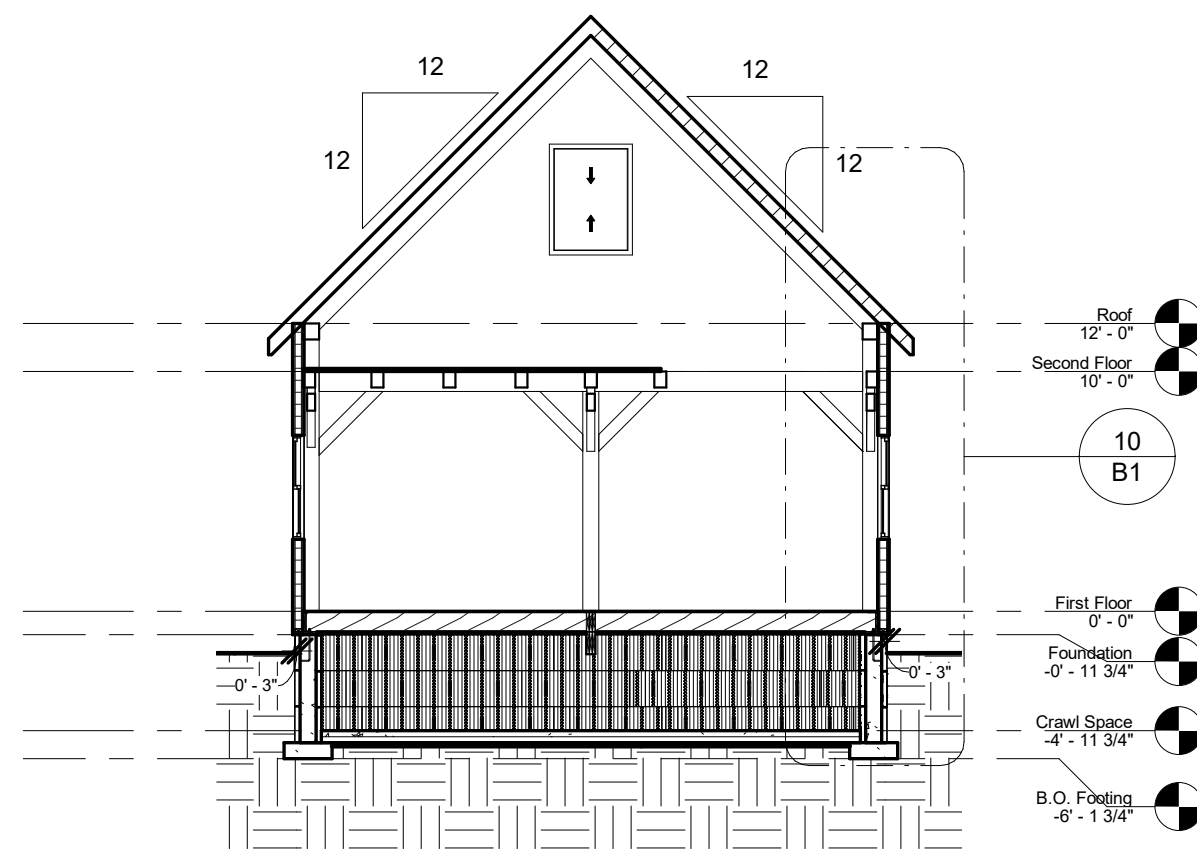
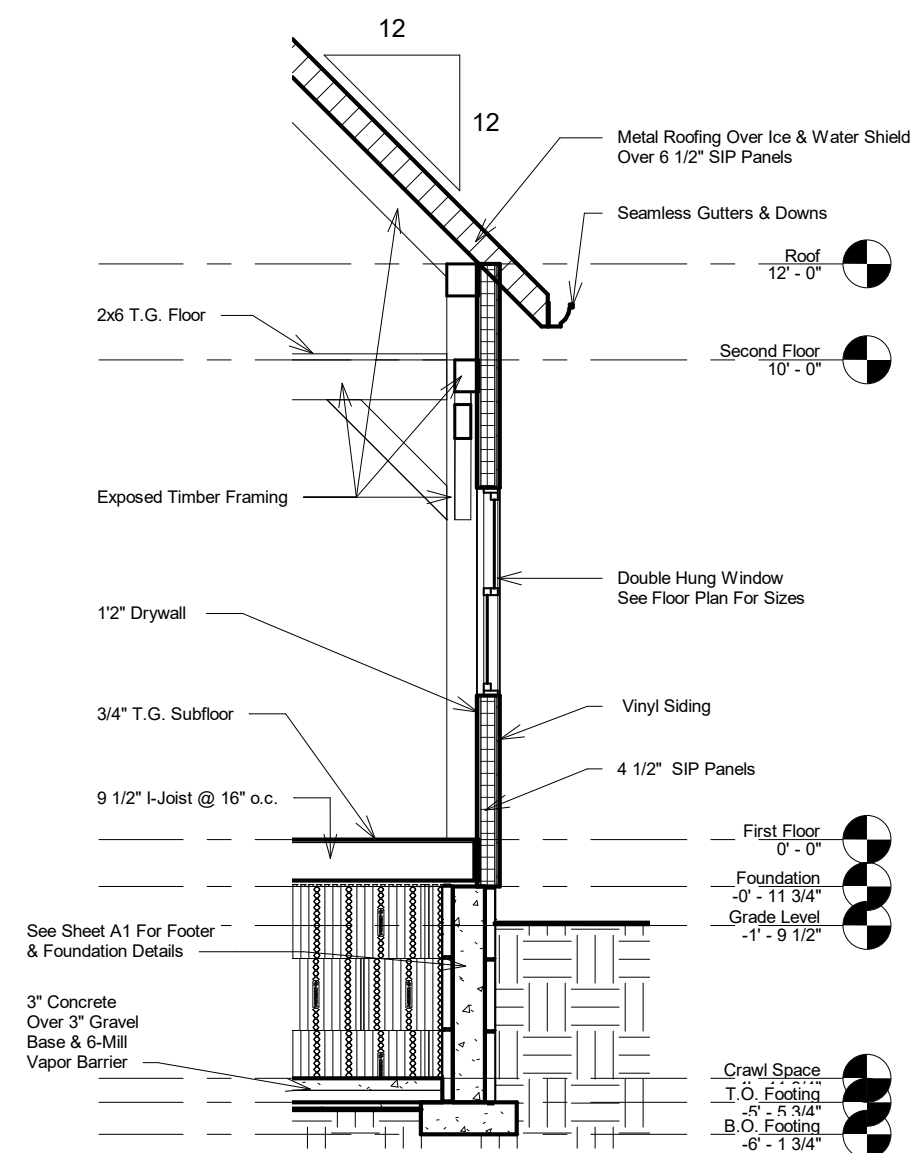
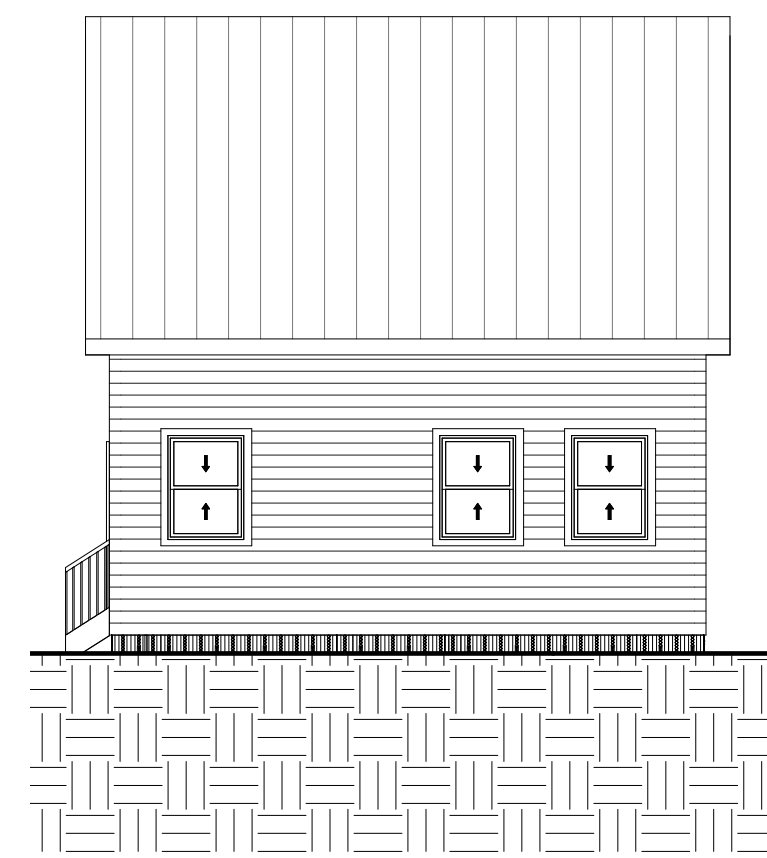
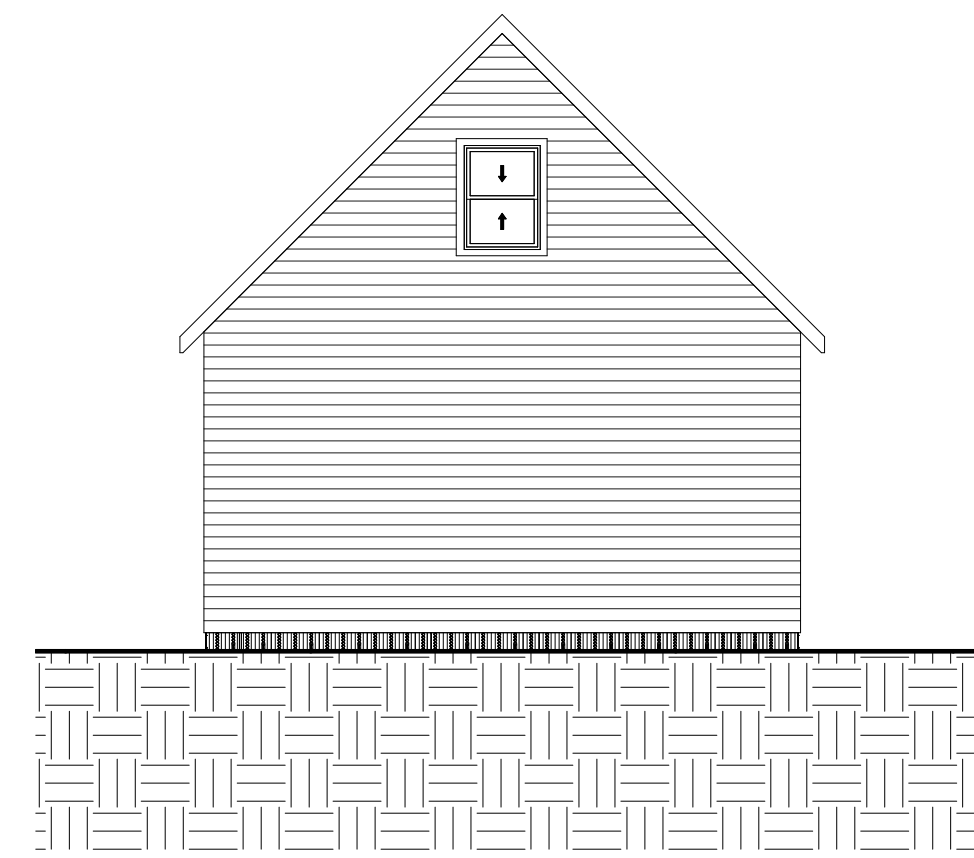
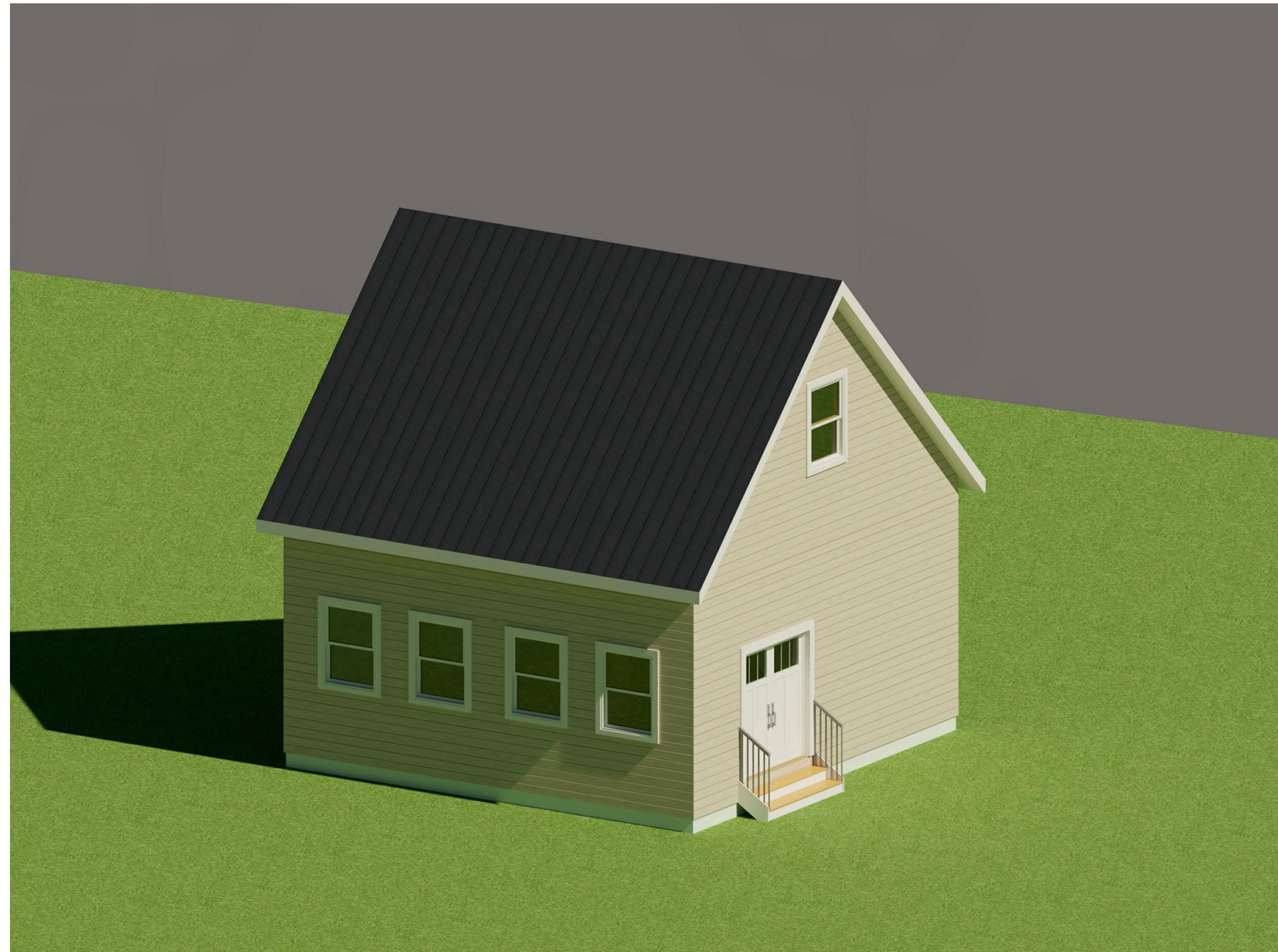
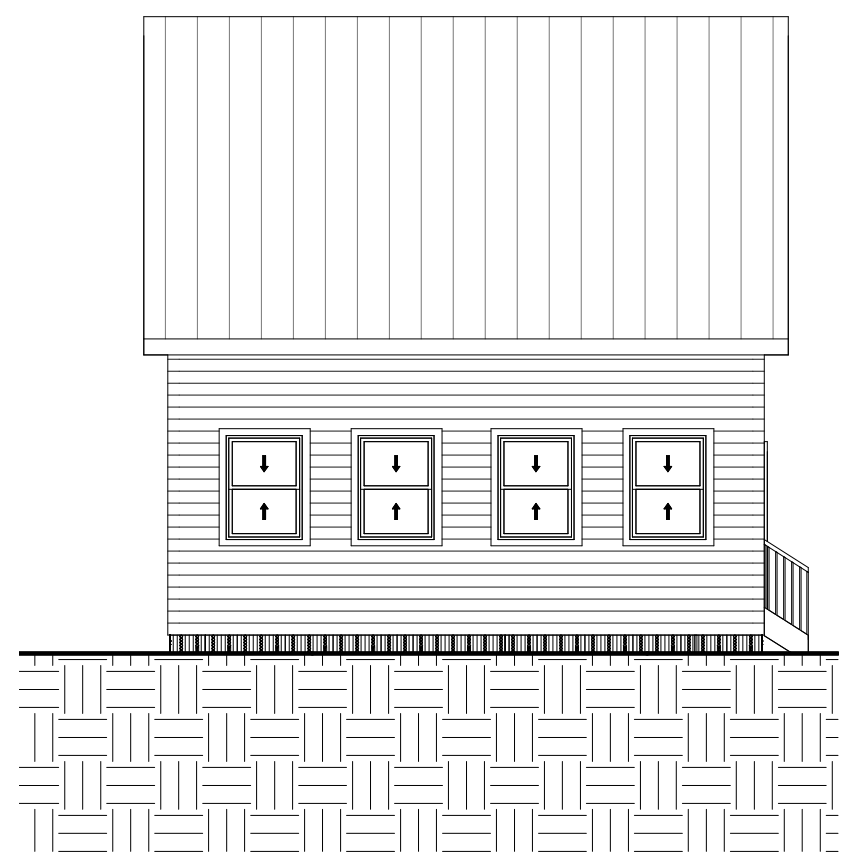
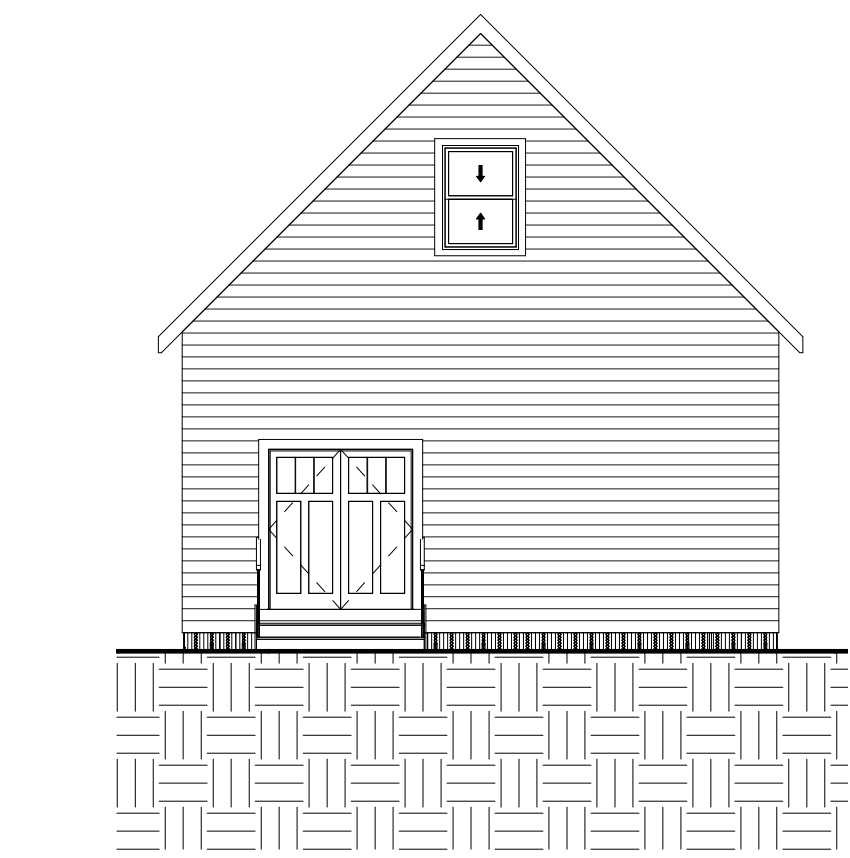

No.	Description	Date

Reynolds  
  
Brochure  
  
Date: 09/27/2020  
Drawn by: RJR  
Checked by: GR  
**B1**  
Scale: As indicated